

FOUR
STROKE

MFS4CD



Exceed the European
Union emission
standards.



California C.A.R.B.
three star rating
for ultra-low
emissions.

FOUR
STROKE

Specifications

Type		Four Stroke
Maximum output	kW (PS)	2.9 (4)
Maximum operating range	r/min	4500-5500
Fuel consumption at W.O.T	L/Hr (gal/Hr)	1.5 (0.40)
Number of cylinder		1
Bore x Stroke	mm (in)	59x45 (2.32x1.77)
Displacement	mL (Cu in)	123 (7.51)
Engine lubrication system		Trochoid pump
Starting system		Manual
Spark plug		NGK DCPR6E
Ignition timing	degree	BTDC3°- BTDC25°
Alternator output		(Option 12V 60W 5A)
Engine oil		Tohatsu 4 Stroke Engine Oil or API Standard (SH,SJ,SL) SAE 10W-30/40
Engine oil capacity	L (qt)	0.45 (0.48)
Fuel tank capacity	L (gal)	1.15 (0.30) Integral tank 12 (3.17) Separate tank (optional)
Speed control		Twist grip type
Gear reduction ratio		2.15 (13:28)
Emission Compliance		EU & EPA & CARB 3-Star

Specifications and descriptions are subject to change without notice.

Dimensions

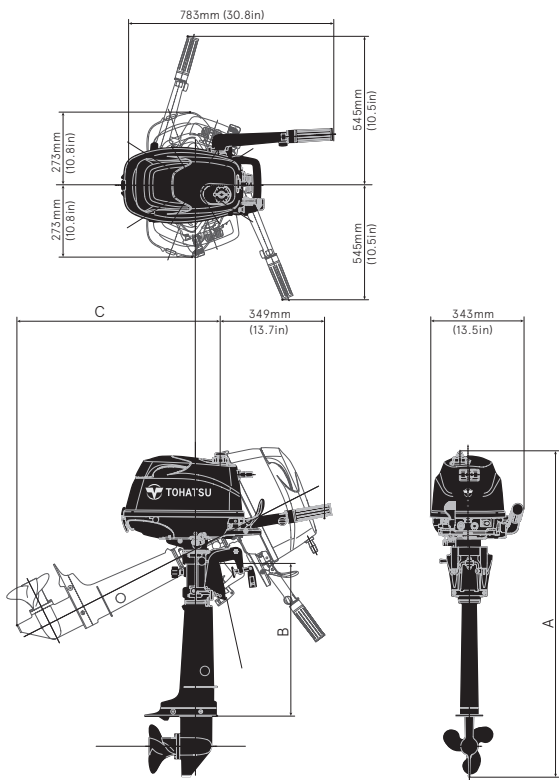

Dry Weight (kg/lbs)

Model	MF
Transom S:	26.1 (58)
Transom L:	26.6 (59)

Dimensions (mm/in)

Model	A	B	C
Transom S:	1067 (42.0)	435 (17.1)	658 (25.9)
Transom L:	1194 (47.0)	562 (22.1)	758 (29.8)

Standard & Optional Equipments

Type	S/L
Electric Starter	-
Manual Recoil Starter	●
Decompression Release	●
Engine Stop Switch Lanyard	●
Alternator	○
Rectifier	○
Dual Tank Connector	●
Transom	15/20
Propeller	●
Analog Tachometer	-
Analog Trim Meter	-
Remote Control Box	-
12L (3.1 Gal) Plastic Fuel Tank	○
1.15L (0.3 Gal) In-tank	●
Tool Kit	●
Emergency Starter Rope	●
Spare Spark Plug	●
Owners Manual	●

● Standard ○ Optional



1-Cylinder



Alternator
(Option)



Charging
System
(Option)



Thermostat



Built-in
Tank



Dual Fuel
System
(Option)



Throttle
Friction



Steering Friction
Adjustment
(FOR TILLER HANDLE MODEL)



High Solid
Paint Coating



Light Weight



Front Shift
Control