

FOUR
STROKE

MFS2.5B



Exceed the European
Union emission
standards.



California C.A.R.B.
three star rating
for ultra-low
emissions.

FOUR
STROKE

Specifications

Type		Four Stroke
Maximum output	kW (PS)	1.8 (2.5)
Maximum operating range	r/min	4500-5500
Fuel consumption at W.O.T	L/Hr (gal/Hr)	1.0 (0.26)
Number of cylinder		1
Bore x Stroke	mm (in)	55x36 (2.17x1.42)
Displacement	mL (Cu in)	85.5 (5.2)
Engine lubrication system		Splash
Starting system		Manual
Spark plug		NGK DCPR6E
Ignition timing	degree	BTDC3°- BTDC25°
Alternator output		-
Engine oil		Tohatsu 4 Stroke Engine Oil or API Standard (SH,SJ,SL) SAE 10W-30/40
Engine oil capacity	L (qt)	0.3 (0.32)
Fuel tank capacity	L (gal)	1 (0.26)
Speed control		Twist grip type
Gear reduction ratio		2.15 (13:28)
Emission Compliance		EU & EPA & CARB 3-Star

Specifications and descriptions are subject to change without notice.

Dimensions

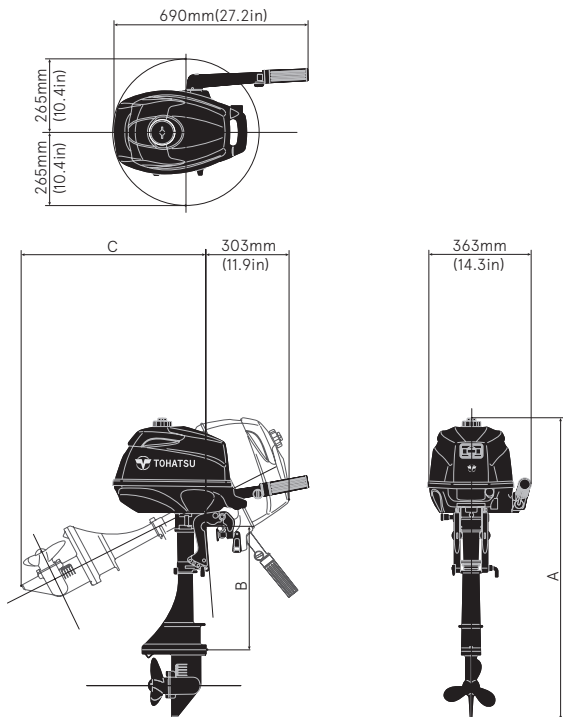

Dry Weight (kg/lbs)

Model	(kg/lbs)
Transom S:	18.4 (41)
Transom L:	19.4 (43)

Dimensions

(mm/in)

Model	A	B	C
Transom S:	1040 (40.9)	435 (17.1)	628 (24.8)
Transom L:	1167 (45.9)	562 (22.1)	728 (28.7)

Standard & Optional Equipments

Type	S/L
Electric Starter	-
Manual Recoil Starter	●
Decompression Release	●
Engine Stop Switch Lanyard	●
Alternator	-
Transom	15/20
Propeller	●
Analog Tachometer	-
Analog Trim Meter	-
Remote Control Box	-
12L (3.1 Gal) Plastic Fuel Tank	-
1L (0.26 Gal) In-tank	●
Tool Kit	●
Emergency Starter Rope	●
Spare Spark Plug	●
Owners Manual	●

● Standard ○ Optional



1-Cylinder



Thermostat



Built-in Tank



Throttle Friction



Forward - Neutral



360° Full Pivot Steering



Steering Friction Adjustment
(FOR TILLER HANDLE MODEL)



High Solid Paint Coating



Light Weight