

# TYPHOON 285

Gris Clair  
Light Grey 2003

# Z55000

GDB/02.2010  
GDB/12.03

## OPTION T285-305-335

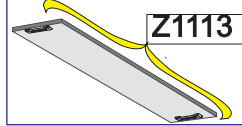

Z1113

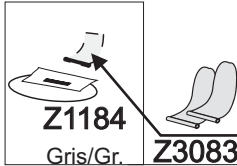

Z1184

Gris/Gr.

Z3083

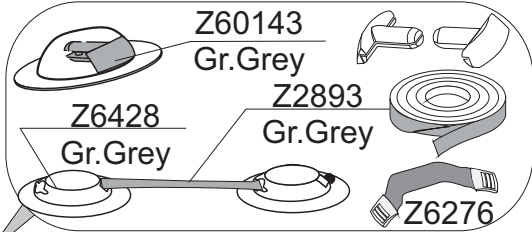

Z60143

Gr.Grey

Z6428

Gr.Grey

Z2893

Gr.Grey

Z6276

Z2846

Z2847

Z3292

Z3293

Z3001

Z3294

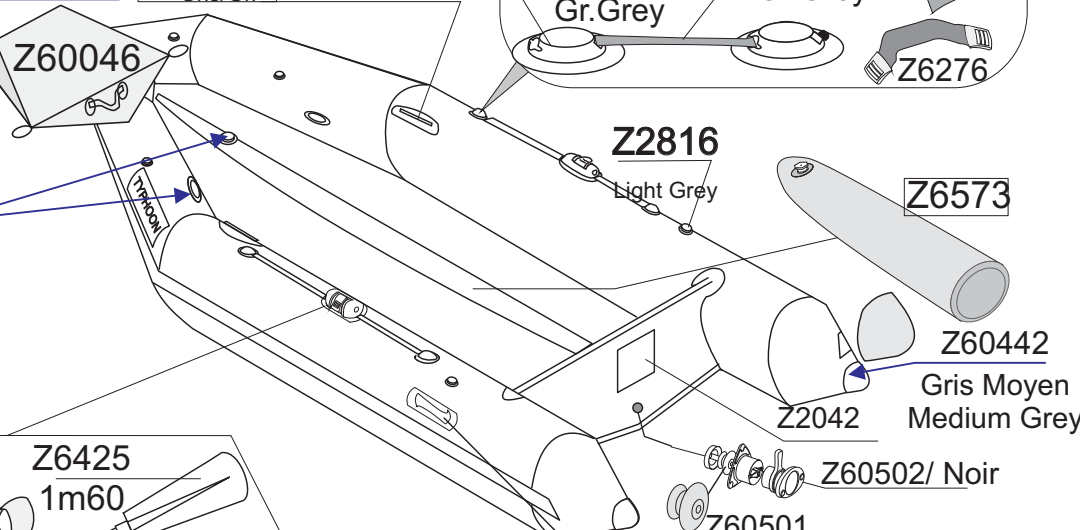

Z60046

Z2816

Light Grey

Z6573

Z60442

Gris Moyen  
Medium Grey

Z2042

Z60502/ Noir

Z60501

Z6425  
1m60

Z2815

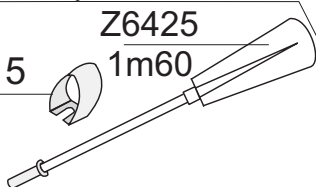

Z60071



Z60044

Kit Gris/Gr.Set 02

Z3077

Z3078

Z60738

Oar Lock/Toilet  
Gris - Grey



Z60037

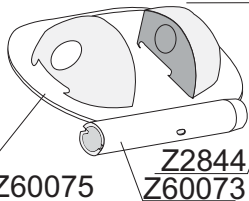

Z60075

Z2844

Z60073

Z60077

Z60078

Z60078

Z6902

Z60381 Plancher/Floorboard  
T285 03 H9 Alu Bleu-Nuit

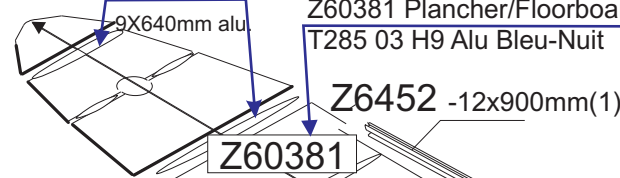

9X640mm alu

Z6452 -12x900mm(1)

Z60381

Z67098

Z60977

Z60811

2008

Z7159

MAN Prop



Z3018

Z3343 - (5+5)  
Bouchon longeron  
12mm rail' stringer cap

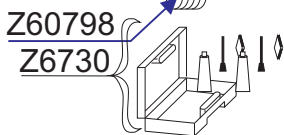

Z60798

Z6730

Z6878 Tableau Noir-  
Black Transom Board

Z6088

Z3327

Glissière Tableau (1)  
Grise/Grey Bracket

Z3141 (10)

Noir/Blk

Z3143 (10)

Gris/Grey

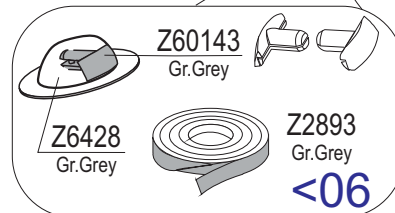

Z60143

Gr.Grey

Z6428

Gr.Grey

Z2893

Gr.Grey

<06

Z2302-AD 53 ROND  
GRIS ZODIAC(2)

Z67154

Z2816

Gr.Grey

Tissu pour réparation: Corps =7041 Gris Clair  
Fabric for repairs : Tube =7041 Light Grey

Fond = Z60395 Bleu Marine  
Bottom = Z60395 Navy Blue